



Ευρωπαϊκή Ένωση  
Ευρωπαϊκό Κοινωνικό Ταμείο



Κυπριακή Δημοκρατία



Διαρθρωτικό Ταμείο  
της Ευρωπαϊκής Ένωσης στην Κύπρο



ΥΠΟΥΡΓΕΙΟ ΠΑΙΔΕΙΑΣ, ΠΟΛΙΤΙΣΜΟΥ, ΑΘΛΗΤΙΣΜΟΥ ΚΑΙ ΝΕΟΛΑΙΑΣ  
Διεύθυνση Μέσης Τεχνικής και Επαγγελματικής Εκπαίδευσης και Κατάρτισης

Το Έργο συγχρηματοδοτείται από το Ευρωπαϊκό Κοινωνικό Ταμείο της Ε.Ε. και την Κυπριακή Δημοκρατία

ΟΝΟΜΑΤΕΠΩΝΥΜΟ: ..... ΤΑΞΗ: .....

Να κατασκευάσετε το συμμετρικό των πιο κάτω σχημάτων ως προς την ευθεία ε.

1)

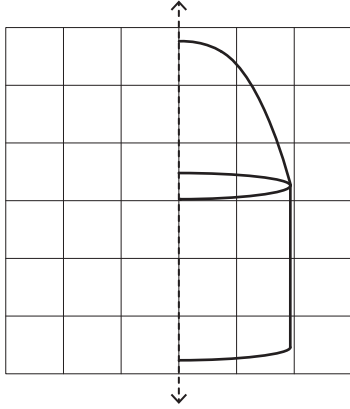

2)

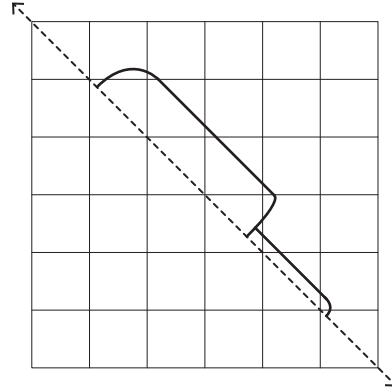

3)

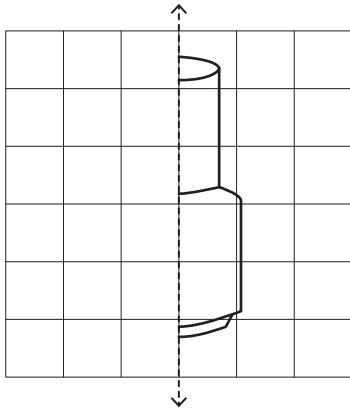

4)

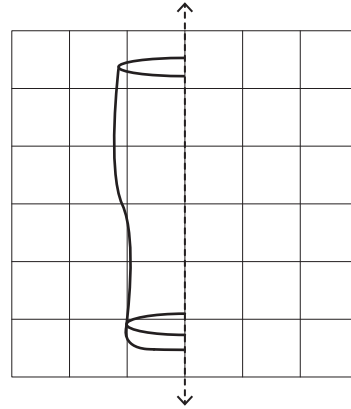

5)

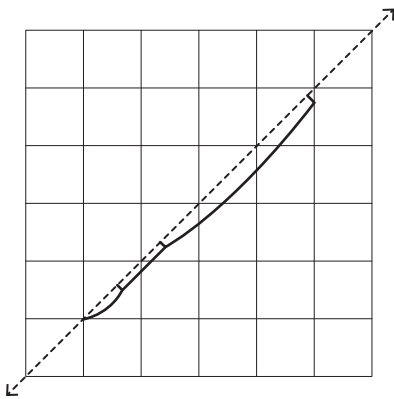

6)

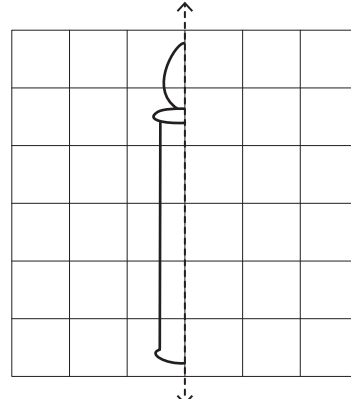

7)

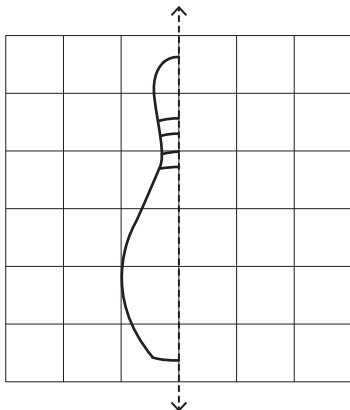

8)

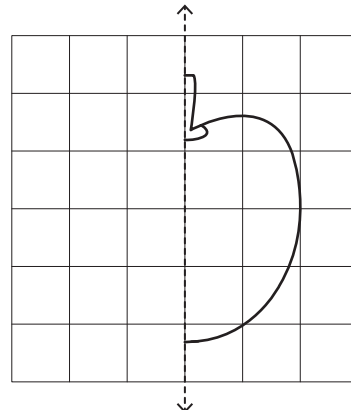

1)

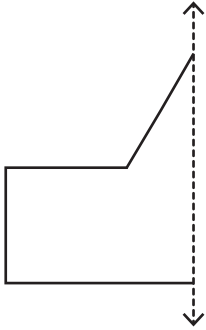

2)

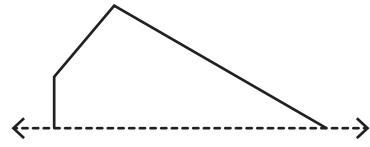

3)

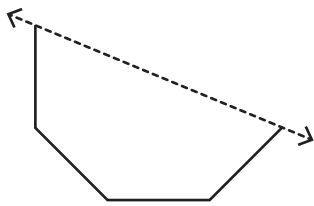

4)

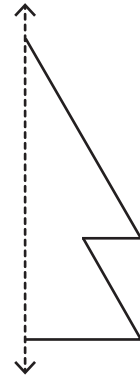

5)

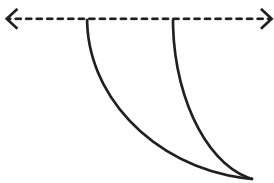

6)

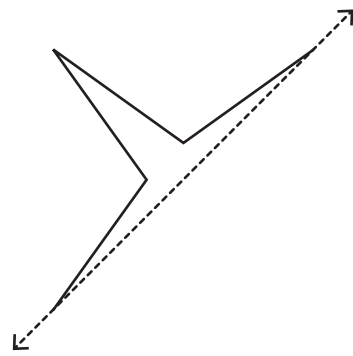

7)

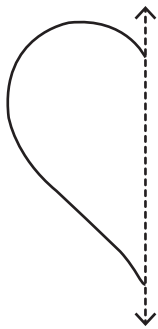

8)

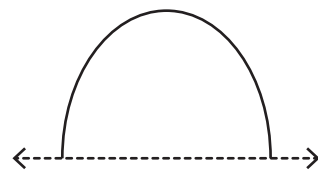

1)

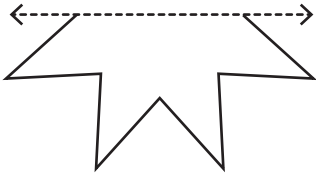

2)

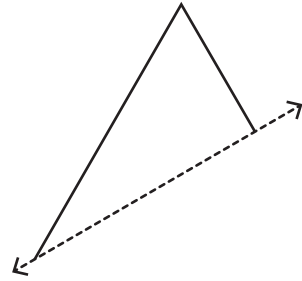

3)

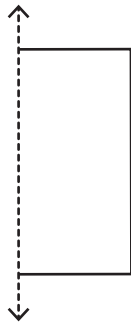

4)



5)

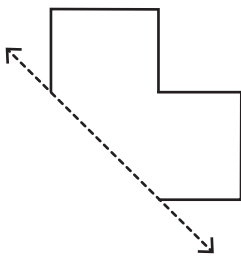

6)

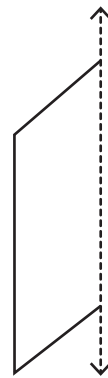

7)

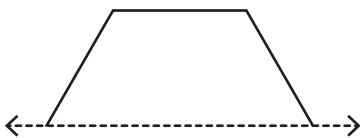

8)

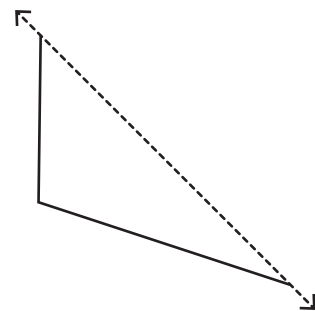

1)

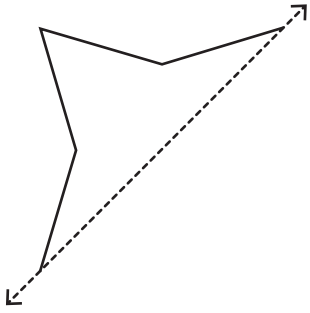

2)

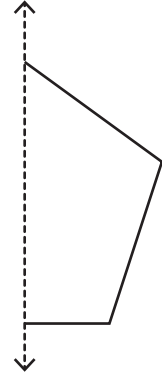

3)

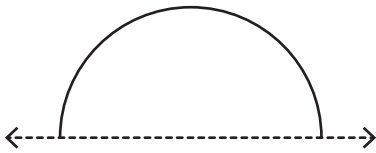

4)

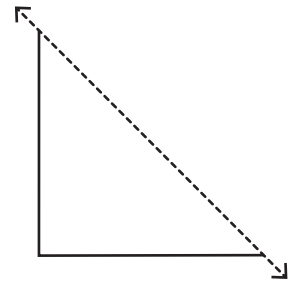

5)

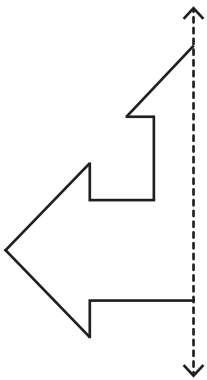

6)

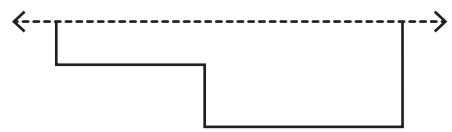

7)

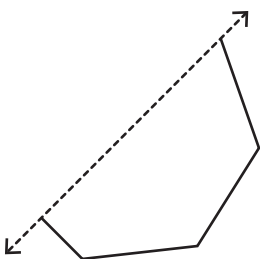

8)

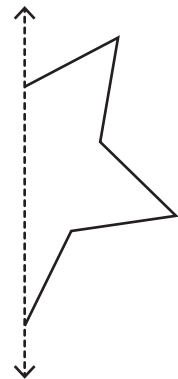

1)

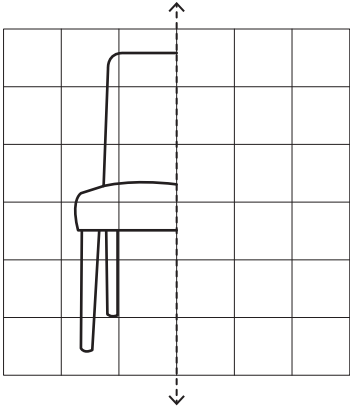

2)

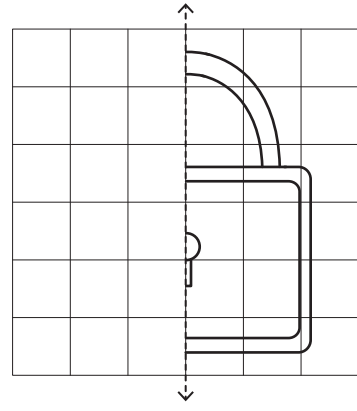

3)

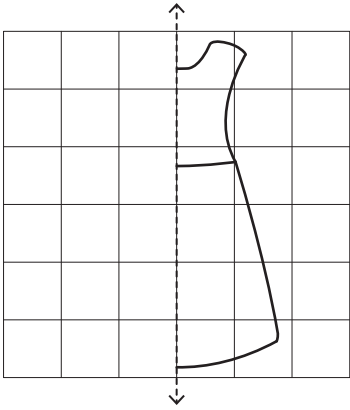

4)

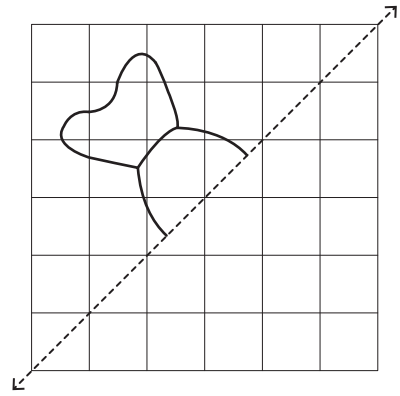

5)

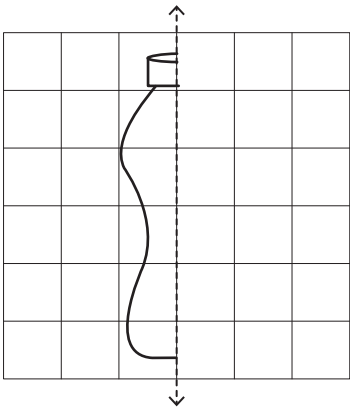

6)

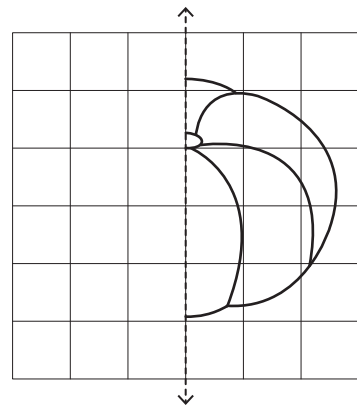

7)

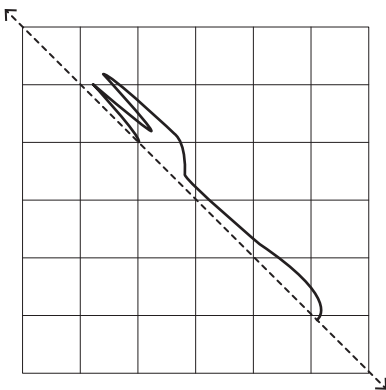

8)

